

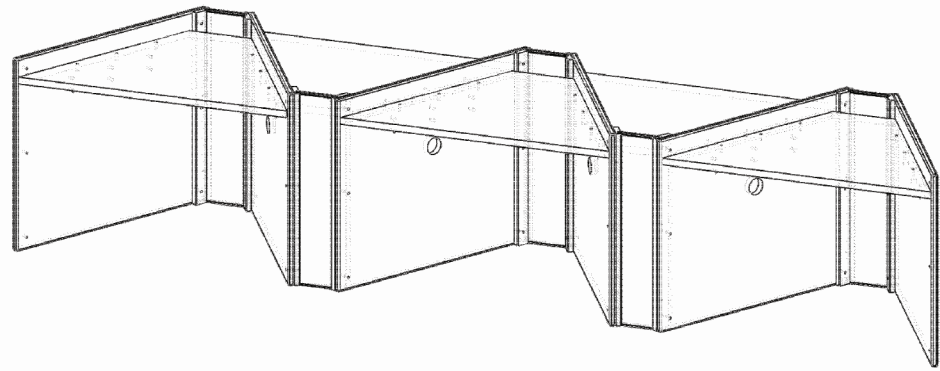

Americana™
Zig-Zag Multi-User Workstations

Assembly Manual

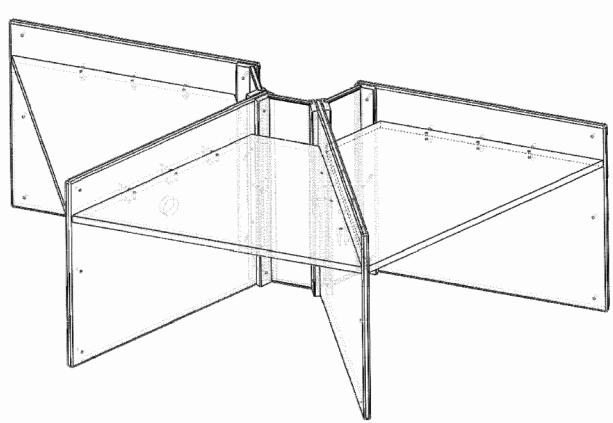

Included parts

Starter Unit:

2 Starter panels:

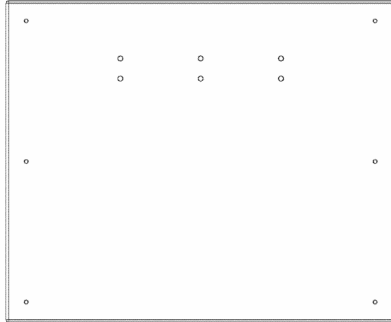

1 Work surface:

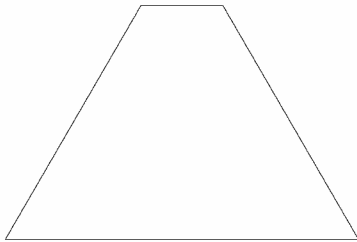

1 Back panel:

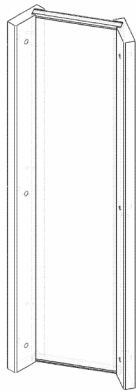

Adder unit:

*Same parts as Starter except

1 Adder panel:

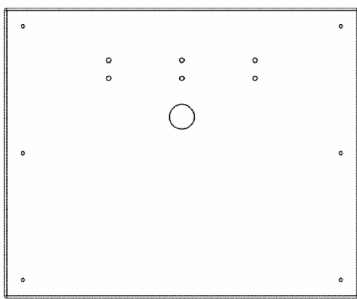

replaces the 2 Starter panels.

Included Hardware

Starter unit



- (2) Metal Brackets
- (6) 1-1/4" Bronze Connector Bolts
- (6) 5/8" Bronze Connector Bolts
- (12) 1" Hex head Bolts
- (12) 7/8" x 5/16" Washers
- (12) Lock washers

Adder Unit:



- (2) Metal Brackets
- (3) 2-1/2" Bronze Connector Bolts
- (3) 1-1/4" Bronze Connector Bolts
(not shown)
- (3) 5/8" Bronze Connector Bolts
- (6) Bronze Connector Bolt Caps
- (6) 1" Hex head Bolts
- (3) 2-1/4" Hex head Bolts
- (3) 5/16" Nuts
- (12) 7/8" x 5/16" Washers
- (9) Lock Washers

Assembly Instructions:

- 1) Attach a metal bracket to a starter panel (panel with no through-bore holes or grommets) using three 1" hex head bolts, each with a washer and lock washer:



- 2) Stand the panel up and attach one end to a back panel using three 1-1/4" bronze connector bolts:



- 3) Screw three 5/8" bronze connector bolts into the unused holes on the starter panel:



- 4) Align and attach an Adder panel with the existing back panel and an additional back panel. Attach these three parts with three 2-3/4" bronze connector bolts and bronze end caps, being sure to tighten all connector bolts with an Alan wrench:



- 5) Attach two metal brackets to the Adder Panel using three 2-1/4" hex head bolts, two washers, a lock washer and a nut:



- 6) Use three 5/8" bronze connector bolts with bronze end caps to close unused holes on the Adder panel:



- 7) Now place a work surface on the metal brackets between the starter and Adder panels:



- 8) Using 1" hex head bolts, each with a washer and lock washer, attach the work surface to the brackets:



- Continue adding Adder panels, back panels, metal brackets and work surfaces to the configuration:

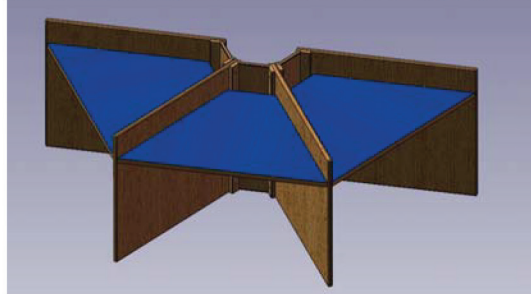

- 9) Using the hardware provided, you may re-arrange these units into a Zig-Zag configuration:



Simply use the extra 1-1/4" bronze connector bolts provided in the Adder hardware in place of the 2-1/2" connector bolts used to attach the back panel to the Adder panel. All other assembly procedures are the same.

Demco[®]
imagine what's possible™

ind Gaylord[®] Americana[®] Zig-zag Multiuser Computer Workstations
earc 2050924

Call 00 9 2 44 or email