

"CATCH THE BUG"

Process
#3

FINAL BUG WIRING

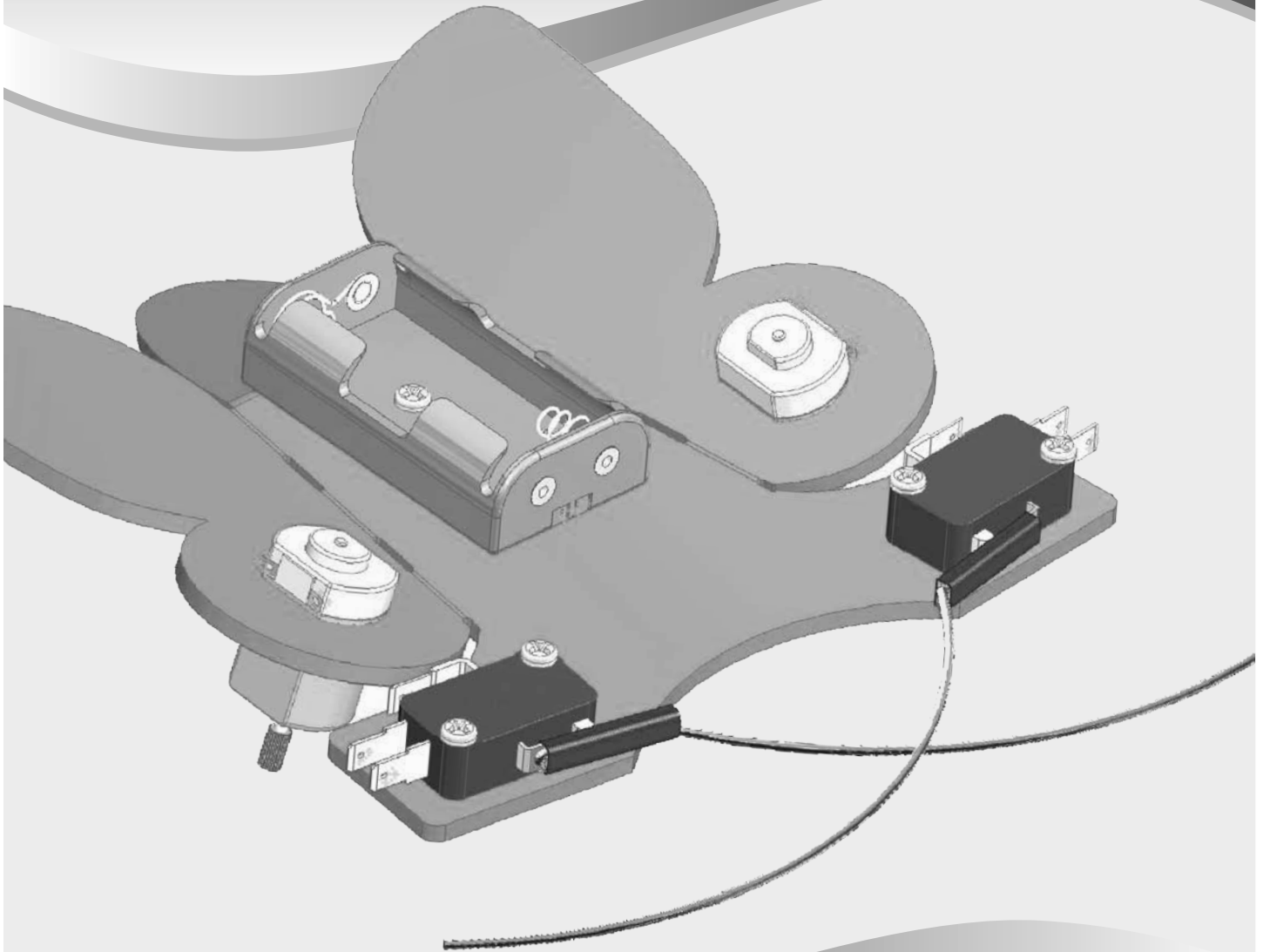

WHERE ARE WE?

- 1) **Body Build**- The mechanical part of the bug is constructed.
- 2) **Electronics Lab**- Bug Experiments teach the fundamentals of electronics.
- 3) **Final Wiring**- Permanent wires are soldered on to "bring the Bug to life."

You are
here.

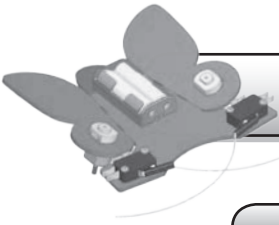

FINAL WIRING

TOOLS NEEDED



Crimper/Stripper



Safety Glasses



Auto Stripper
(optional- for small wires)



Soldering Pencil and
Lead-Free Solder

Find the perfect tools and lead-free solder at teachergeek.com

PARTS NEEDED



1- Spade Connector



30" (~72cm)- Stranded Wire

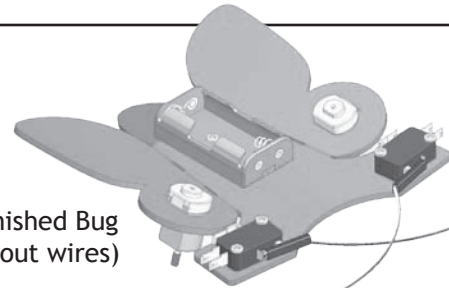

1- Finished Bug
(without wires)

TIPS AND TRICKS

Strip .25" (6mm) of insulation from the ends of wires (before connecting them).



Twist together the stranded ends of wires.



Hold-off on soldering until all the wires have been put on your bug.



Hook wires through terminal holes, then pinch (smoosh hooked wire) to secure.

Strip wires here
Cut wires here

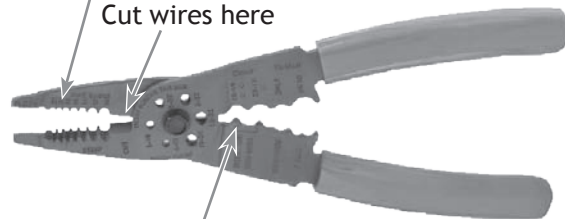

Crimp spade connectors here.



Bend out switch terminals to provide more room for wiring.

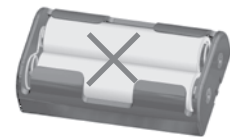

Make sure batteries are removed while wiring.

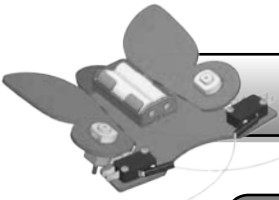

THE HARNESS

1. Cut two 5.5" (14cm) wires (any color).
2. Strip the wire ends.
3. Twist the wires together (at one end).

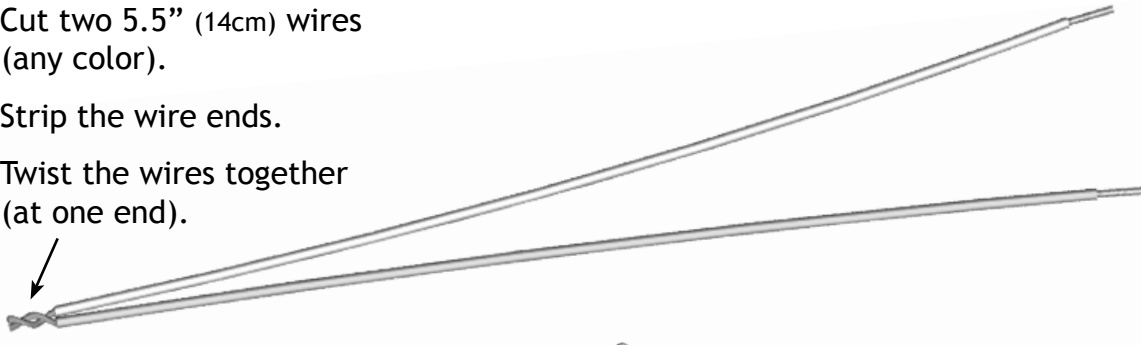

4. Place the twisted end of the wires into a spade connector.

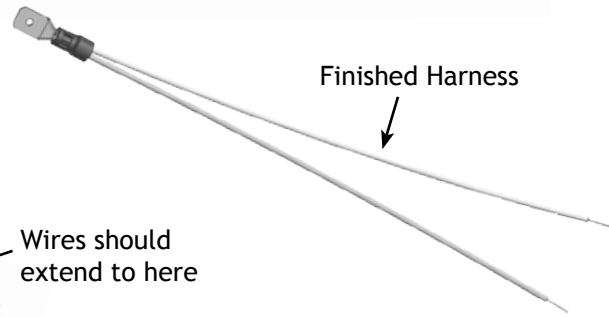

Wires should extend to here

5. Attach the harness to the rear motor terminals (M).

THE ON/OFF SWITCH



The Spade connector is the Bug's On/Off Switch. Place it into the rear spring on the battery holder to turn the Bug on.

Switch Harness

M

M

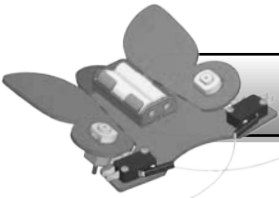

OPTION 1: THE ULTIMATE CHALLENGE

Use your knowledge of electronics to figure out the final Bug wiring.

YOUR FINAL BUG SHOULD:

- a) go forward when turned on
- b) reverse the motor directly behind the switch that is pushed
- c) not short-circuit

Use alligator clip leads to experiment creating the final Bug wiring. When you figure it out, complete the schematic below and show your teacher.

Permanent wires can be placed onto your Bug and soldered once you receive your teachers signature. See page 8 for soldering instructions.

Here's some help: Wires **A** and **B** are part of your final Bug wiring.

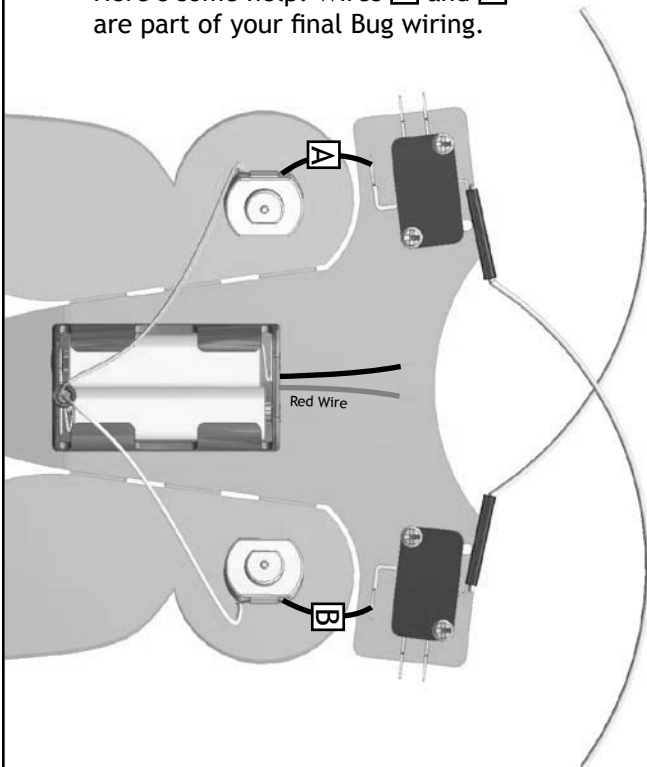

YOU FIGURED IT OUT?

Great!!! Complete this schematic according to your final Bug wiring.

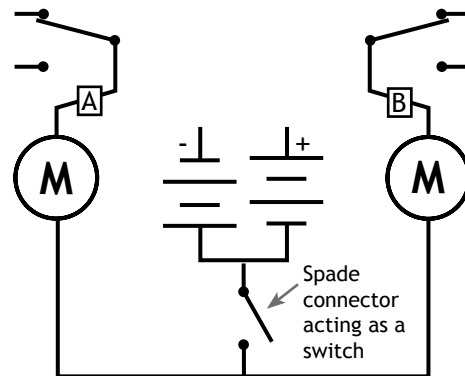

Show the your teacher.

Teacher Signature:

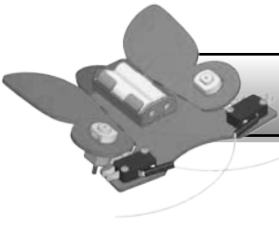

OPTION 2: WIRE BY SCHEMATIC

Use the schematic to create your final Bug wiring.

1. Use the schematic to place the permanent wires on your Bug, but don't solder them
2. Show your teacher your Bug wiring.
3. Permanent wires can be soldered once you receive your teachers signature. See page 8 for soldering instructions.

SCHEMATIC FOR FINAL BUG WIRING

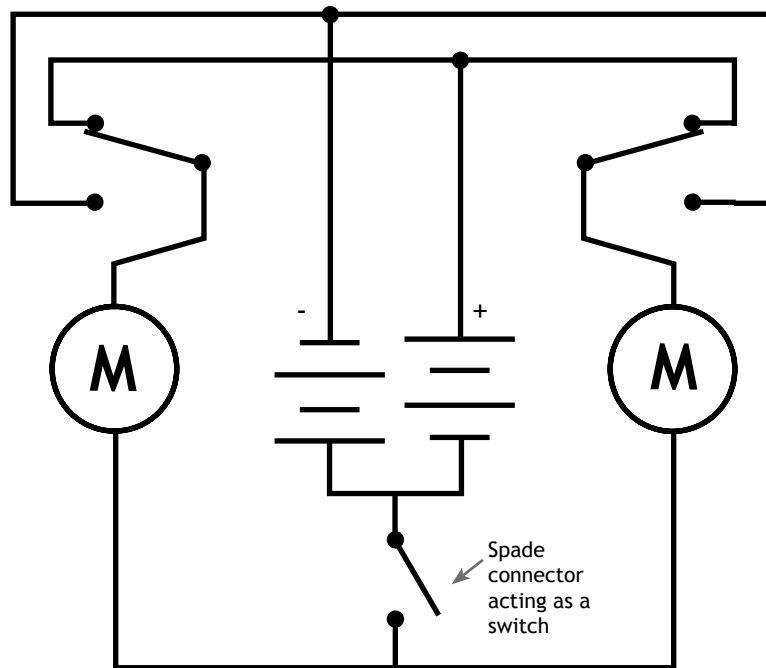

YOUR FINAL BUG SHOULD:

- a) go forward when turned on
- b) reverse the motor directly behind the switch that is pushed
- c) not short-circuit

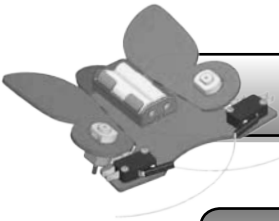

FINAL WIRING

OPTION 3: STEP-BY-STEP WIRING

Create your final Bug wiring in three steps (4 including soldering).

STEP 1

1. Cut two 2.5" (6.4cm) wires (any color).
2. Strip the wire ends.
3. Attach the wires as shown with **A** and **B**.

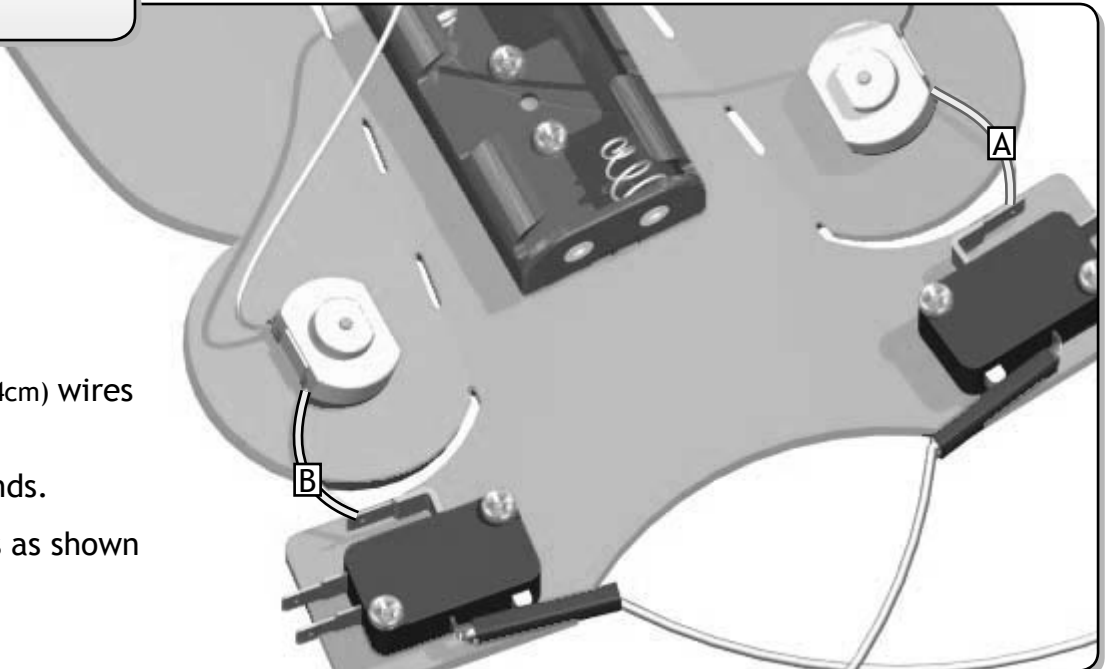

STEP 2

4. Attach the battery holder wires to the switch:
C = red wire
D = black wire

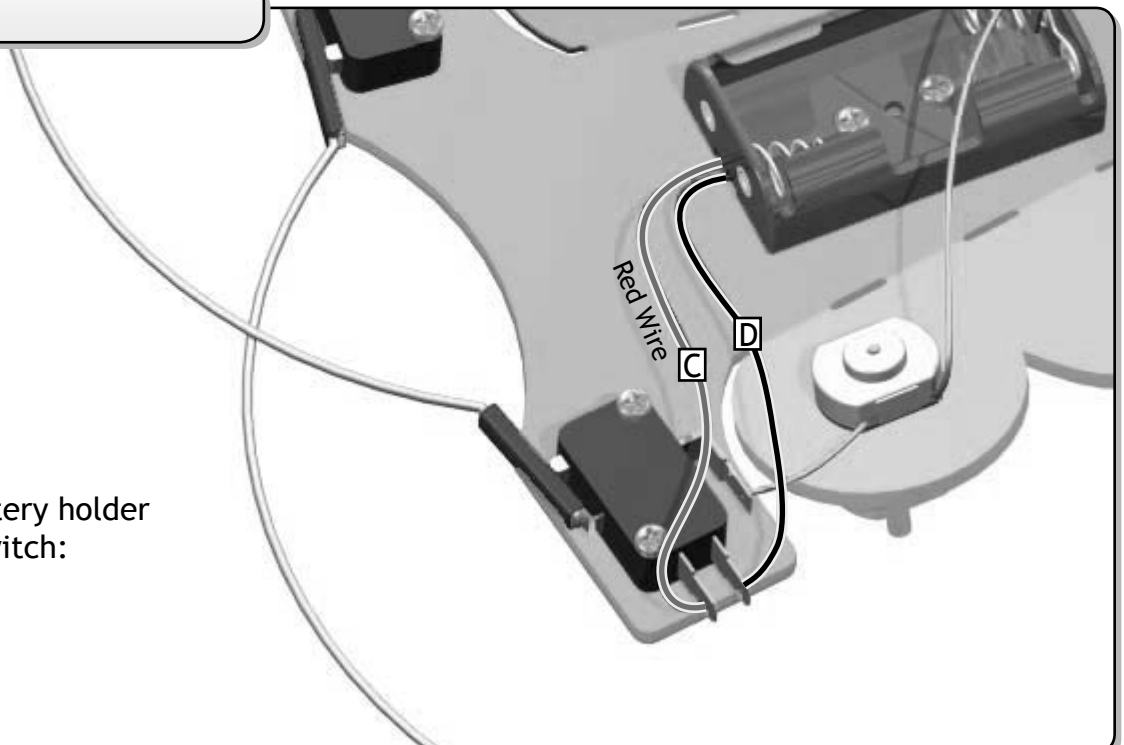

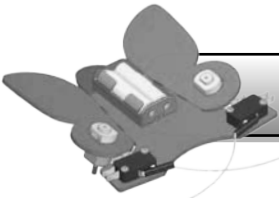

STEP 3

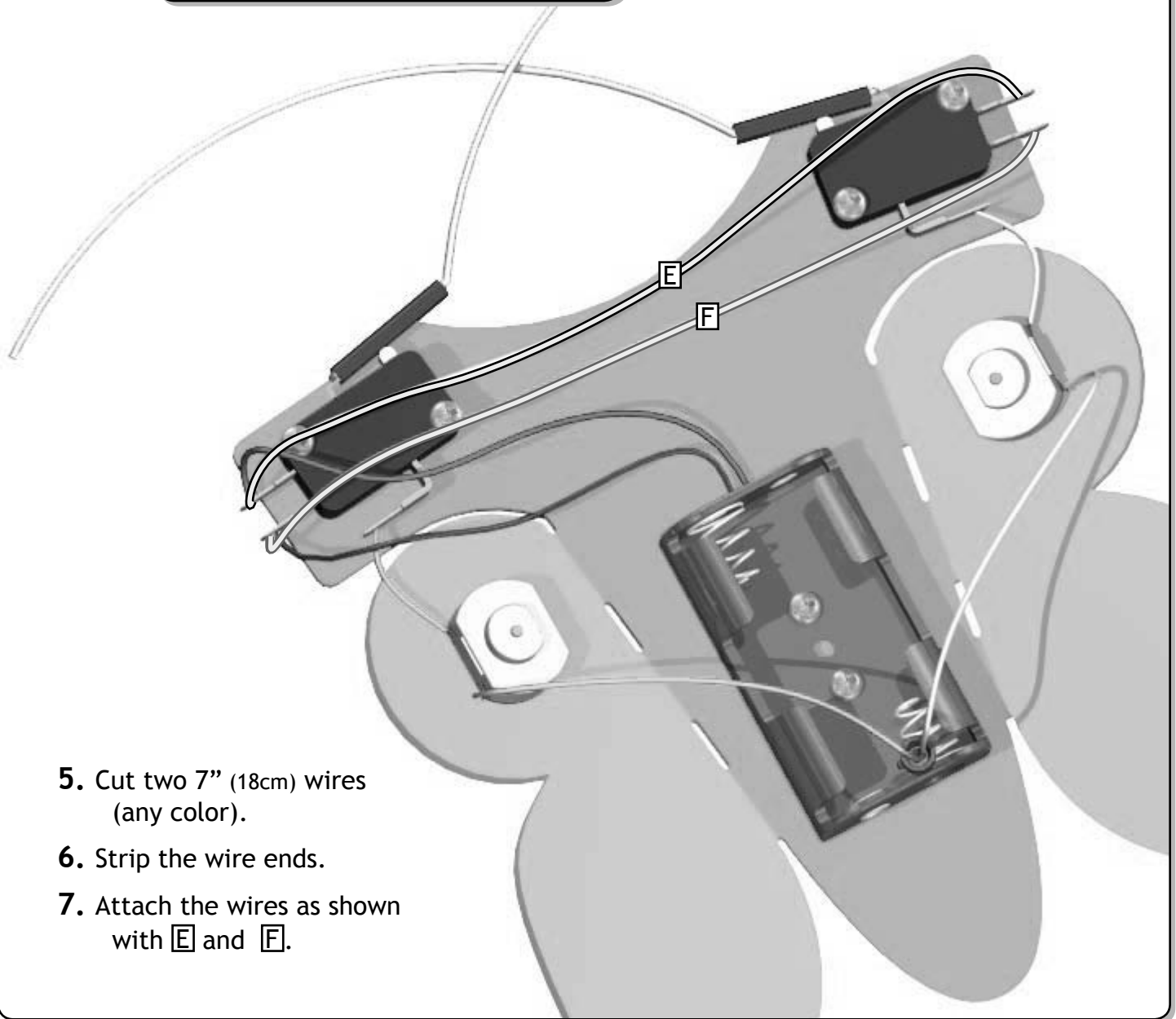

5. Cut two 7" (18cm) wires (any color).
6. Strip the wire ends.
7. Attach the wires as shown with **E** and **F**.

It's time to solder. See page 8 for instructions.

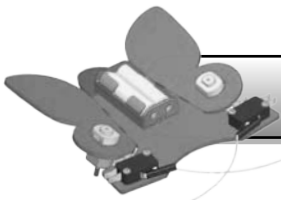

HOW TO SOLDER

WHEN ELSE DO YOU GET TO MELT METAL?

1. Place the tip of the soldering iron firmly against the wire and terminal.

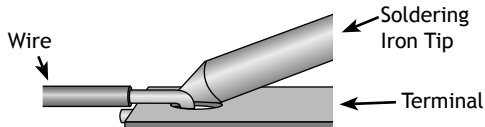

2. Push the solder in between the terminal, wire and soldering iron.

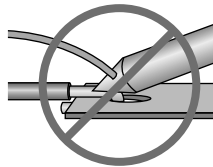
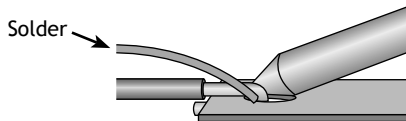

Pushing the solder directly onto the soldering iron tip will cause a bad solder joint.

3. Add solder until a thin coating flows over and between components. Pull the solder away, followed by the the soldering iron.

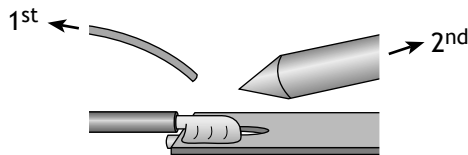

4. Do not move the components until the solder has cooled.



Adult Supervision Required.
Be Careful of Burns.
Wear Safety Glasses.

TIP TIPS (SOLDERING IRON TIPS)

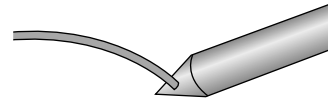

Tin the Tip: Lightly coat the tip with solder before and after use.

The tip is coated in iron (which rusts). Tinning it after you finish will protect it from rusting. Tinning it before use will help it conduct heat.

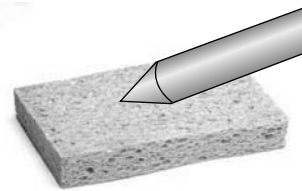

Shiny Tips Work Better: Keep the tip clean by wiping it from time to time on a damp sponge.

GOOD SOLDER JOINT



Solder flows over and between components.

BAD SOLDER JOINT



Solder forms as a ball. Fix by applying heat with the soldering iron until solder flows between components.

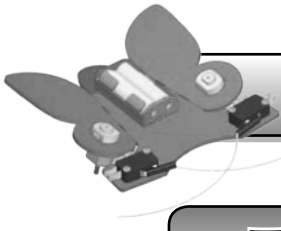

TROUBLESHOOTING GUIDE

Problem: Batteries become hot

Culprit: The circuit has a short circuit (bad wiring, or bridged solder joints).

Fix: Quick!!! Turn off the Bug and remove the batteries. Check the wiring.

Problem: Bug turns instead of going straight

Note: Bugs will usually turn slightly because, in order for them to go forward, one motor is turning forwards while the other is turning in reverse. The motors used on the Bug have slightly greater speed and torque when turning forwards. You can adjust for this by moving the motors up or down in the bug body.

Culprit 1: The Bug will turn if the wings are bent at different angles.

Fix: Reheat and re-bend the wings.

Culprit 2: Tire Rubber was cut at an angle or uneven.

Fix: Trim the tire rubber so the end is straight (perpendicular with the hole).

Culprit 3: The tire material is pushed up tight against the motor housing, or up to high on the motor shaft
Fix: Slide the tire material so that it extends slightly past the motor shaft, and away from the motor housing.

Culprit 4: Something is wrapped around your motor shaft or tire.

Fix: Clean it.

Culprit 5: Bad soldering, or lack of soldering.

Fix: Make sure all connections have been soldered. A non-soldered connection can limit the amount of electricity passing through it, causing a motor to turn slower.

Problem: Bug moves when it should be turned off

Note: The Bug will reverse when the Bug is off (spade connector is removed from the battery holder spring) and the feelers are pushed. It's part of the way it was designed. We call it "playing dead."

Fix: In order to fully turn off the Bug, you must remove the batteries.

Culprit 2: The wiring is wrong.

Fix: Check the wiring.

Problem: Bug Bounces or Jitters when it moves

Culprit: Tire Rubber is cut at an angle.

Fix: Trim the tire rubber so the end is straight (perpendicular with the hole).

Problem: Bug will not move (motors will not turn)

Culprit 1: The batteries are dead.

Fix: Replace the batteries.

Culprit 2: The wiring is wrong.

Fix: Check the wiring.

Culprit 3: The Bug is not turned on.

Fix: Place the spade connector into the battery holder spring closest to the back of the Bug.

Problem: Bug will not reverse

Culprit 1: The Bug is wired wrong.

Fix: Check the wiring.

Culprit 2: Spade connector is in the wrong side of the battery holder.

Fix: Place the spade connector into the battery holder spring closest to the back of the Bug.

Problem: Bug spins "on a dime" when it should go forwards

Culprit 1: Motors are wired backwards and/or put in upside-down.

Fix: Make sure the motor terminals are on the outside of the Bug.
Check the wiring.